

THE PROPERTY OF THE DRAWING IS ESTABLISHED BY LAW. IT IS FORBIDDEN TO PRODUCE OR SHOW IT TO THIRD PART. WITHOUT A WRITTEN AGREEMENT.

Item	Name	Q.ty
1	R.5.SCH	1
2	V.TCE5x20	1
3	WKA.14.14.80	1

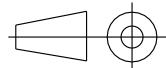
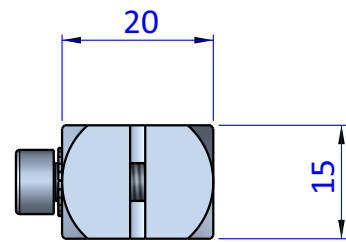
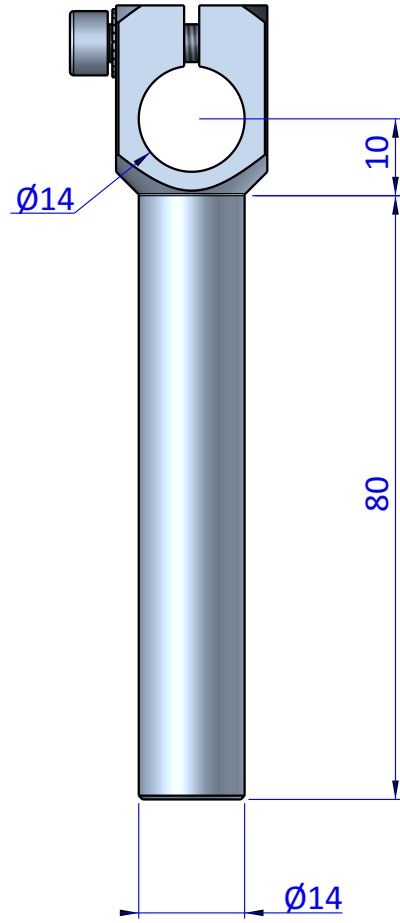
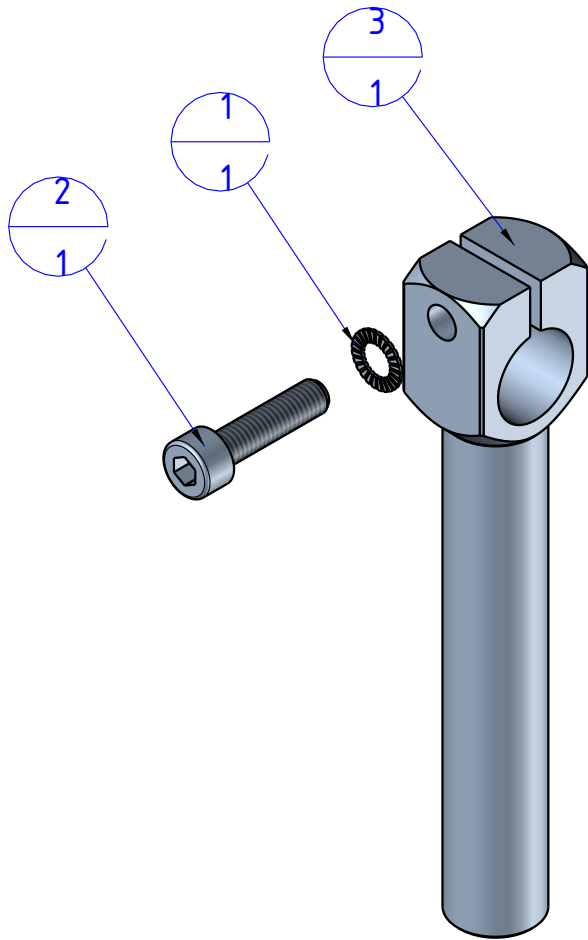

DESIGNED FROM FPS Automation		REVIEW A
DATE 21/09/2020	WEIGHT 0,035kg	
CODE CA.WKA.14.14.80		

Format **A4**

UNI 936-76

GENERAL TOLERANCE

UNI - ISO 2768

CLASSE f

DESCRIPTION

CA.WKA.14.14.80