

XP-B15

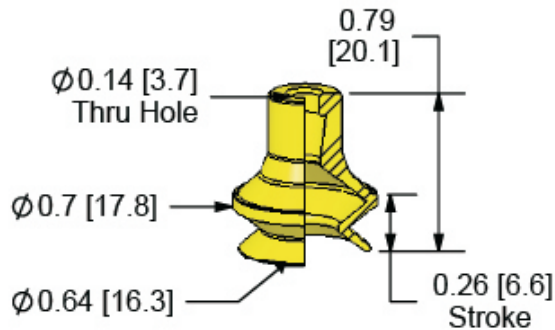

CUP DIAMETER	15 mm
CUP WEIGHT: oz. (g)	0.04 (1.1)
INTERNAL VOLUME: cu. in. (cc)	0.07 (1.2)
FORCE @ 6" Hg: lb. (N)	0.7 (3.1)
FORCE @ 18" Hg: lb. (N)	1.3 (5.8)
MINIMUM RADIUS: in. (mm)	0.2 (5.1)
SHEAR LOAD²: lb. (N)	0.7 (3.1)

MATERIAL - NITRILE



PART NUMBER

XP-B15N