

## XP-B15

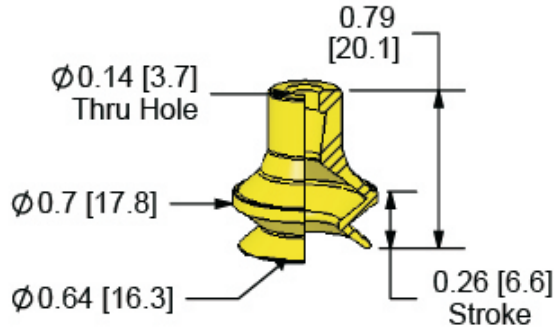

<b>CUP DIAMETER</b>	15 mm
<b>CUP WEIGHT: oz. (g)</b>	0.04 (1.1)
<b>INTERNAL VOLUME: cu. in. (cc)</b>	0.07 (1.2)
<b>FORCE @ 6" Hg: lb. (N)</b>	0.7 (3.1)
<b>FORCE @ 18" Hg: lb. (N)</b>	1.3 (5.8)
<b>MINIMUM RADIUS: in. (mm)</b>	0.2 (5.1)
<b>SHEAR LOAD<sup>2</sup>: lb. (N)</b>	0.7 (3.1)

**MATERIAL - SILICONE**



PART NUMBER

**XP-B15S**