

THE PROPERTY OF THIS DRAWING IS ESTABLISHED BY LAW
IT IS FORBIDDEN TO REPRODUCE IT OR SHOW IT TO THIRD PARTY
WITHOUT A WRITTEN AGREEMENT.

MODIFICATIONS:

7	10
8	11
9	12

VARIED DIMENSIONS AS OF DATE:

MODIFICATIONS:

1	4
2	5
3	6

VARIED DIMENSIONS AS OF DATE:

Format **A3**
UNI 936-76

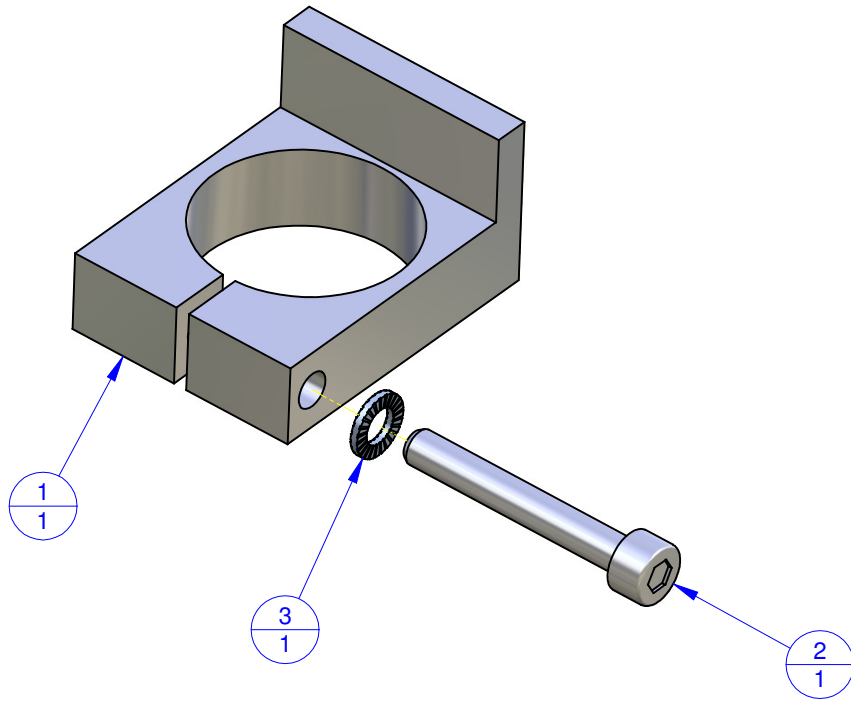

Object Number	Name	QTY
1	ANS.30	1
2	V.TCE5X35	1
3	R.5.SCH	1

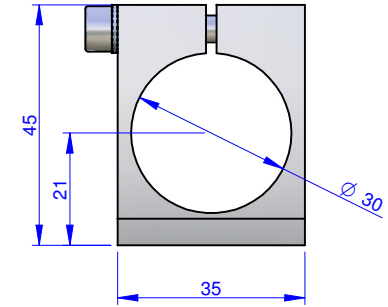

FP Services		DESIGNED FROM FPSERVICES	
		DATE 09/2013	WEIGHT 0,017 kg
GENERAL TOLERANCE: UNI - ISO 2768 CLASSE f		CODE CA.ANS.30	

