

THE PROPERTY OF THE DRAWING IS ESTABLISHED BY LAW
IT IS FORBIDDEN TO PRODUCE OR SHOW IT TO THIRD PARTY
WITHOUT A WRITTEN AGREEMENT.

Item	Name	Qty.
1	CA.08.09.18	1
2	GSEG.141890	1

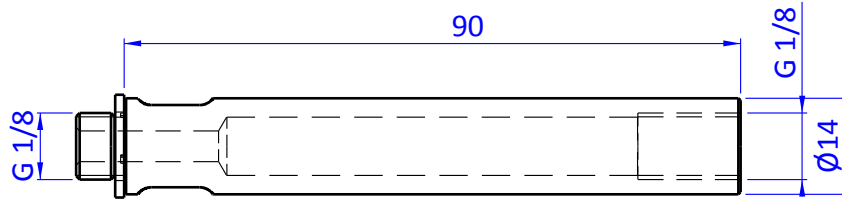
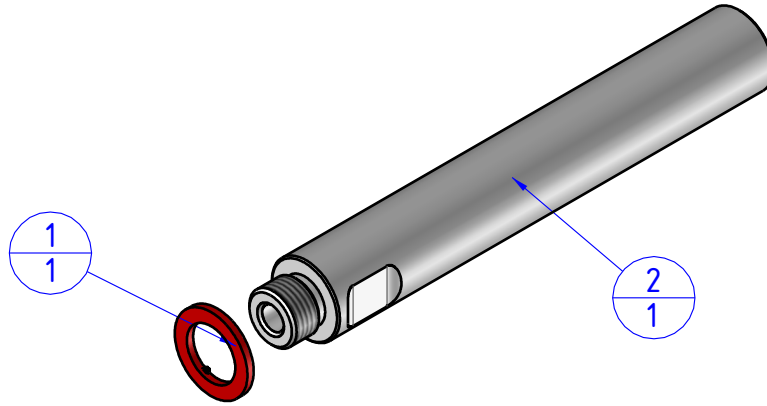

MODIFICATIONS

7	10
8	11
9	12

VARIED DIMENSIONS AS OF DATE:

MODIFICATIONS

1	4
2	5
3	6

VARIED DIMENSIONS AS OF DATE:

Format A4
UNI 936-76

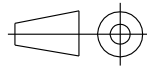

GENERAL TOLERANCE		DESCRIPTION		DESIGNED FROM	
UNI - ISO 2768				FPSERVICES	
CLASSE f				DATE	WEIGHT
				31/07/2017	0,026kg
				CODE	
				CA.GSEG.141890	