

THE PROPERTY OF THIS DRAWING IS ESTABLISHED BY LAW
IT IS FORBIDDEN TO REPRODUCE IT OR SHOW IT TO THIRD PARTY
WITHOUT A WRITTEN AGREEMENT.

MODIFICATIONS: VARIED DIMENSIONS AS OF DATE:

7	10
8	11
9	12

MODIFICATIONS: VARIED DIMENSIONS AS OF DATE:

1	4
2	5
3	6

Format **A3**
UNI 936-76

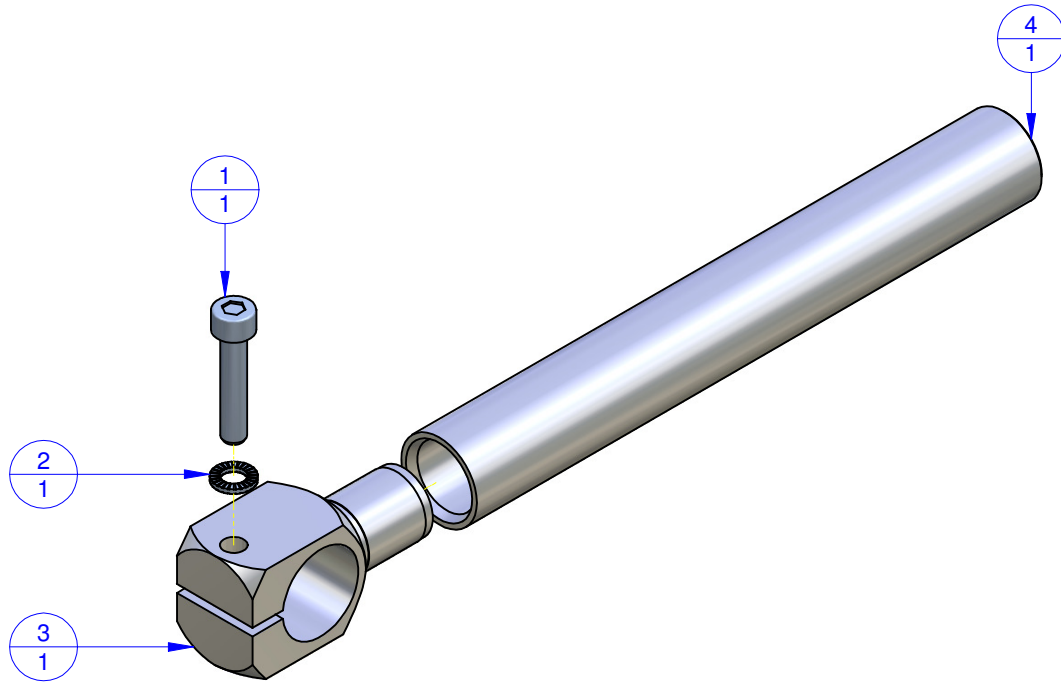

Object Number	Name	QTY
1	VTCE5X25	1
2	R.5.SCH	1
3	WKA.20.1	1
4	WKA.20.150	1

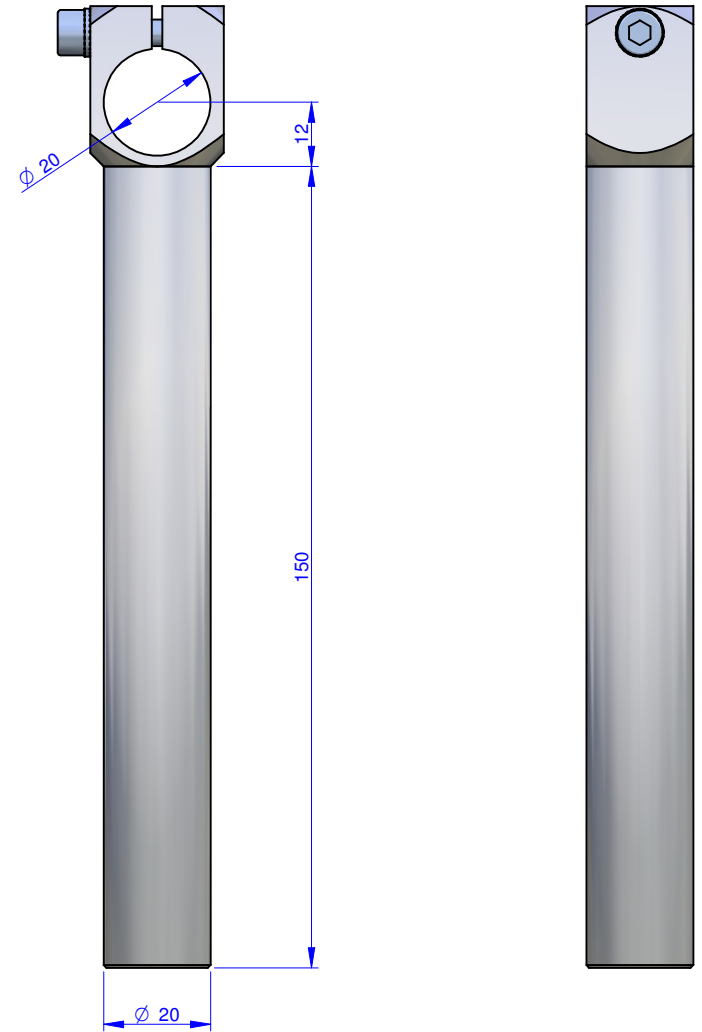

FP Services		DESIGNED FROM FPSERVICES	
GENERAL TOLERANCE: UNI - ISO 2768 CLASSE f		DATE 12/2014	WEIGHT 0,089 kg
DESCRIPTION		CODE CA.WKA.20.20.150	

