

MCGB series

TWIN-GUIDE CYLINDER

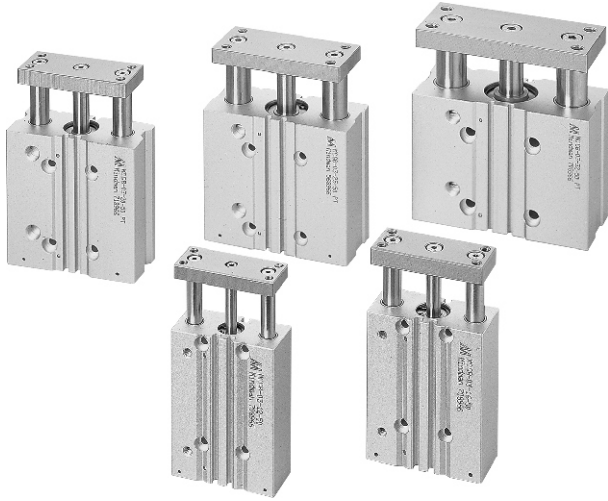

Order example:

MCGB - 03 - 12 - 50 - BSP

MODEL

TUBE I.D.

STROKE

PURPOSE / TYPE OF BEARING

Code	Purpose / Type of bearing
03	Stop / Slide bearing
23*	Push / Linear bush bearing

PORT THREAD
Blank: PT thread
BSP: BSP thread
NPT: NPT thread

※ Could attach a table for the use as a lifter.

Installation of sensor switch

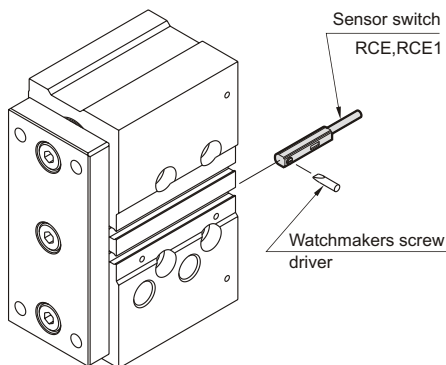

Features:

- Proven track record in manufacturing precision guided cylinders.
- Multi-Ports as standard enabling two direction mounting option.
- Flush fitting sensors.
- Inbuilt high density rubber pad absorbs energy at the end of stroke.
- Magnetic as standard.

Specification:

Model	MCGB		
Model			
Acting type	Double acting		
Tube I.D.(mm)	12, 16	20, 25, 32, 40	50, 63
Port size	M5×0.8	PT 1/8	PT 1/4
Medium	Air		
Operating pressure range	1~9.9 kgf/cm ²		
Proof pressure	15 kgf/cm ²		
Ambient temperature	-5~+60°C (No freezing)		
Cushion	With rubber cushion pad		
Lubrication	Not required		
Sensor switch	RCE, RCE1		

Table for standard stroke

Series variety	Bearing type	Tube I.D.	Stroke (mm)														
			10	20	25	30	40	50	75	100	125	150	175	200			
MCGB -03	Slide bearing	φ 12															
		φ 16															
		φ 20															
		φ 25															
		φ 32*															
		φ 40															
		φ 50															
MCGB -23	Linear bush bearing	φ 12															
		φ 16															
		φ 20															
		φ 25															
		φ 32															
		φ 40															
		φ 50															

※ 1.MCGB-03 ~Tube I.D. φ 32: 25mm for the shortest standard stroke.
2.Please consult us if stroke out of specification.

Capacity graph

Capacity for the use as a stopper~

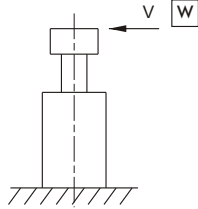

Linear bush bearing type is not available as a stopper.

Stop capacity

MCGB-03...30st

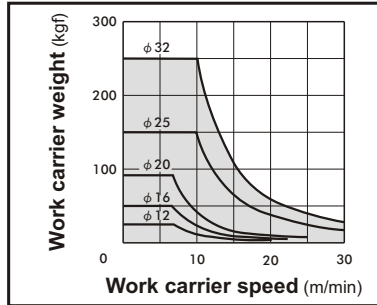

Normal lateral load

MCGB-03...30st

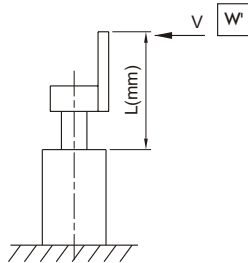
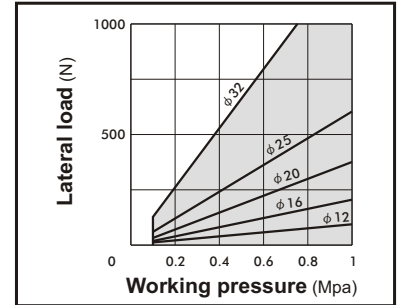

For the use of attaching a plate to the link bar, choose a bore size referring to the formula below.

Coefficients for conversion

$$W = W' \times \frac{L}{\ell}$$

MCGB series	$\phi 12$	$\phi 16$	$\phi 20$	$\phi 25$	$\phi 32$
ℓ	40	42	42	42	44

W: The maximum weight of the work carrier in the above graph for the stopper's capacity.

Capacity for the use as a lifter~

Allowable eccentricity load for the use as a lifter (at supply pressure 0.5MPa)

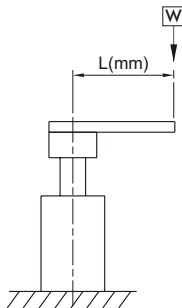

Show the dynamic allowable value at L(mm) eccentricity from the center of the guide rod.

Slide bearing

MCGB-03...10-50st

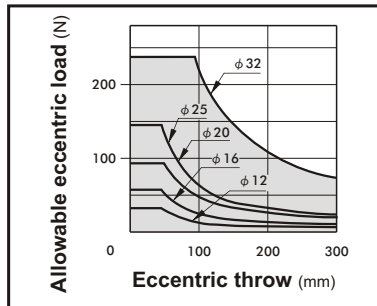

Slide bearing

MCGB-03...75-200st

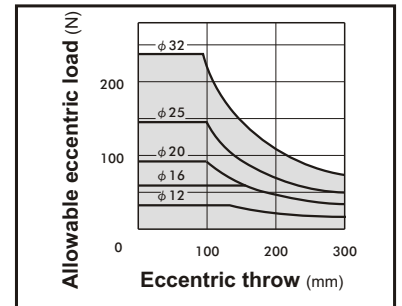

Linear bush bearing

MCGB-23...10-50st

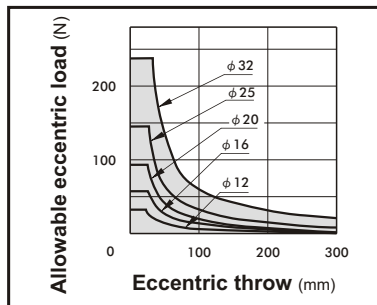

Linear bush bearing

MCGB-23...75-200st

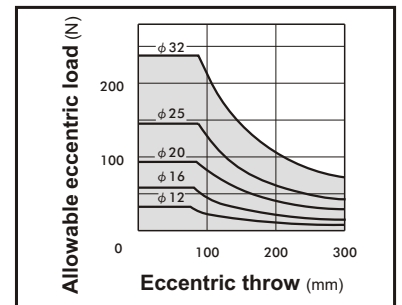

Capacity table

Allowable lateral load :

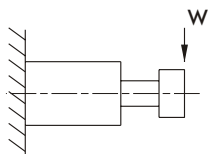

Shows the dynamic allowable value, when actuating the cylinder with lateral load W at the guide rods' top (vertical load against the guide rods).

(N)

Tube I.D.	Bearing type	Stroke (mm)												
		10	20	25	30	40	50	75	100	125	150	175	200	
$\phi 12$	Slide bearing	31	24	/	19	16	13	37	31	/	/	/	/	
	Linear bush bearing	23	17	/	14	34	30	23	19	/	/	/	/	
$\phi 16$	Slide bearing	50	39	/	32	27	24	54	45	/	/	/	/	
	Linear bush bearing	36	29	/	24	59	52	40	33	/	/	/	/	
$\phi 20$	Slide bearing	/	51	/	44	39	35	54	46	74	66	59	54	
	Linear bush bearing	/	43	/	36	98	87	69	57	46	40	36	32	
$\phi 25$	Slide bearing	/	68	/	59	52	46	72	61	98	88	79	72	
	Linear bush bearing	/	67	/	56	148	132	105	87	70	62	55	50	
$\phi 32$	Slide bearing	/	/	165	/	/	/	129	106	90	138	123	111	101
	Linear bush bearing	/	/	104	/	/	/	74	165	138	114	100	90	81

Allowable rotating torque :

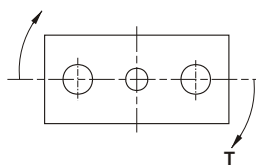

Shows the dynamic allowable value, when actuating the cylinder with a rotating torque T at the guide rods' top.

(N.m)

Tube I.D.	Bearing type	Stroke (mm)												
		10	20	25	30	40	50	75	100	125	150	175	200	
$\phi 12$	Slide bearing	0.64	0.48	/	0.39	0.32	0.28	0.75	0.63	/	/	/	/	
	Linear bush bearing	0.47	0.35	/	0.29	0.71	0.62	0.4	0.38	/	/	/	/	
$\phi 16$	Slide bearing	1.14	0.9	/	0.74	0.63	0.55	1.23	1.04	/	/	/	/	
	Linear bush bearing	0.84	0.66	/	0.54	1.35	1.19	0.93	1.76	/	/	/	/	
$\phi 20$	Slide bearing	/	1.14	/	1.21	1.07	0.95	1.49	1.25	2.03	1.81	1.63	1.48	
	Linear bush bearing	/	1.19	/	0.99	2.69	2.4	1.89	1.56	1.26	1.1	0.98	0.88	
$\phi 25$	Slide bearing	/	2.19	/	1.88	1.65	1.47	2.31	1.94	3.15	2.8	2.52	2.3	
	Linear bush bearing	/	2.14	/	1.79	4.74	4.22	3.36	2.78	2.25	1.98	1.76	1.59	
$\phi 32$	Slide bearing	/	/	6.61	/	/	/	5.16	4.23	3.59	5.52	4.93	4.45	4.06
	Linear bush bearing	/	/	4.17	/	/	/	2.95	6.6	5.52	4.56	4.02	3.59	3.24

Anti-roll accuracy :

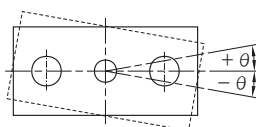

- The values are the deflection angle against the piston rod.
- Exclusive factor of the guide rods' deflection.

Tube I.D.	Bearing type	Anti-roll accuracy
		θ
$\phi 12$	Slide bearing	$\pm 0.09^\circ$
	Linear bush bearing	$\pm 0.06^\circ$
$\phi 16$	Slide bearing	$\pm 0.08^\circ$
	Linear bush bearing	$\pm 0.06^\circ$
$\phi 20$	Slide bearing	$\pm 0.08^\circ$
	Linear bush bearing	$\pm 0.03^\circ$
$\phi 25$	Slide bearing	$\pm 0.07^\circ$
	Linear bush bearing	$\pm 0.05^\circ$
$\phi 32$	Slide bearing	$\pm 0.07^\circ$
	Linear bush bearing	$\pm 0.03^\circ$

MCGB-03 Inside structure & Parts list

TWIN-GUIDE CYLINDER



$\phi 12 \sim \phi 32$

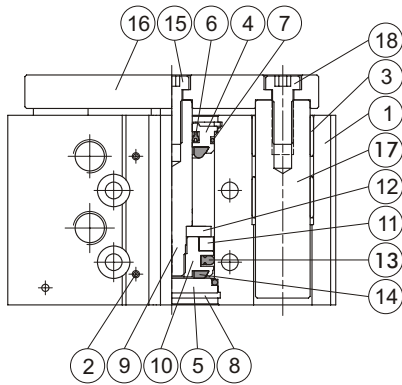

$\phi 40 \sim \phi 63$

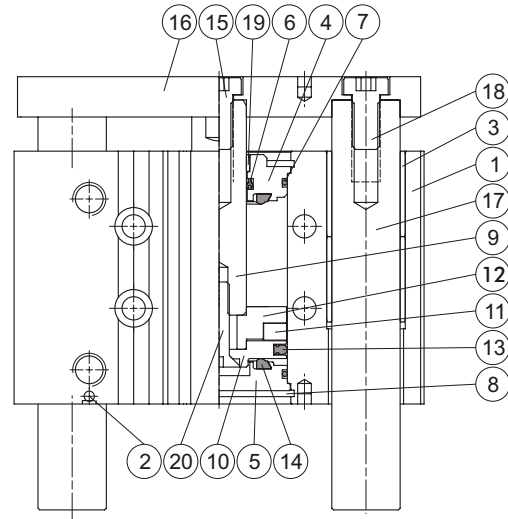

Material :

No.	Part name	Tube I.D.							
		12	16	20	25	32	40	50	63
1	Body	Aluminum alloy							
2	Ball	Stainless steel							
3	Slide bearing	Brass							
4	Rod cover	Aluminum alloy							
5	Head cover	※ 1	Carbon steel			Aluminum alloy			
6	Rod packing	NBR							
7	Cover ring	NBR							
8	Snap ring	Spring steel							
9	Piston rod	Stainless steel		Medium carbon steel					
10	Piston	Aluminum alloy							
11	Magnet ring	Magnet material							
12	Magnet holder	Stainless steel				Aluminum alloy			
13	Piston packing	NBR							
14	Head cushion	NBR							
15	Bolt	SCM							
16	Plate	Carbon steel							
17	Guide rod	Medium carbon steel							
18	Screw	SCM							
19	Rod bush	—				Brass			
20	Piston bolt	—				SCM			

※ 1 : Aluminum alloy

Cylinder weight :

(unit:g)

Model	Basic weight MCGB-03	Stroke 5 mm MCGB-03
Tube I.D.		
$\phi 12$	191	21
$\phi 16$	283	28
$\phi 20$	450	45
$\phi 25$	670	63
$\phi 32$	1,210	90
$\phi 40$	1,474	88
$\phi 50$	2,540	140
$\phi 63$	3,345	157

MCGB-23 Inside structure & Parts list

TWIN-GUIDE CYLINDER



$\phi 12 \sim \phi 32$

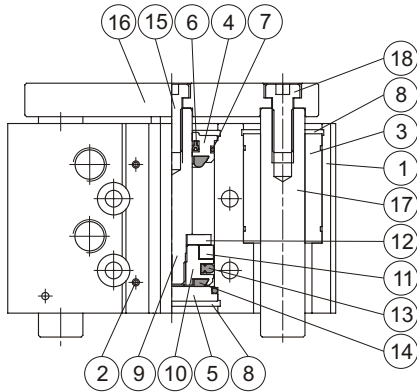

$\phi 40 \sim \phi 63$

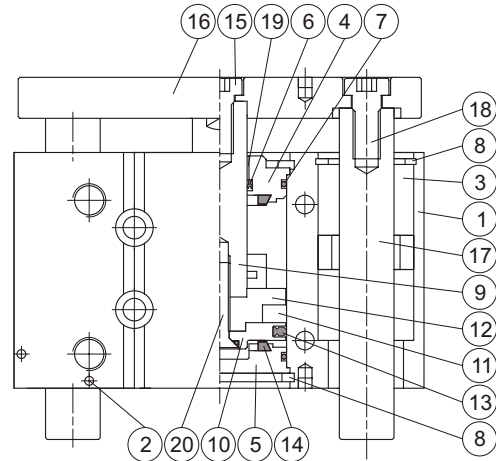



Material :

No.	Part name	Tube I.D.								
		12	16	20	25	32	40	50	63	
1	Body	Aluminum alloy								
2	Ball	Stainless steel								
3	Linear bush bearing	—								
4	Rod cover	Aluminum alloy								
5	Head cover	※ 1	Carbon steel			Aluminum alloy				
6	Rod packing	NBR								
7	Cover ring	NBR								
8	Snap ring	Spring steel								
9	Piston rod	Stainless steel			Medium carbon steel					
10	Piston	Aluminum alloy								
11	Magnet ring	Magnet material								
12	Magnet holder	Stainless steel				Aluminum alloy				
13	Piston packing	NBR								
14	Head cushion	NBR								
15	Bolt	SCM								
16	Plate	Carbon steel								
17	Guide rod	Bearing steel								
18	Screw	SCM								
19	Rod bush	—			Brass					
20	Piston bolt	—			SCM					

※ 1 : Aluminum alloy

Cylinder weight : (unit:g)

Model	Basic weight MCGB-23	Stroke 5 mm MCGB-23
Tube I.D.		
$\phi 12$	211	18
$\phi 16$	260	30
$\phi 20$	470	45
$\phi 25$	740	60
$\phi 32$	1,170	85
$\phi 40$	—	—
$\phi 50$	—	—
$\phi 63$	—	—

MCGB-03/MCGB-23

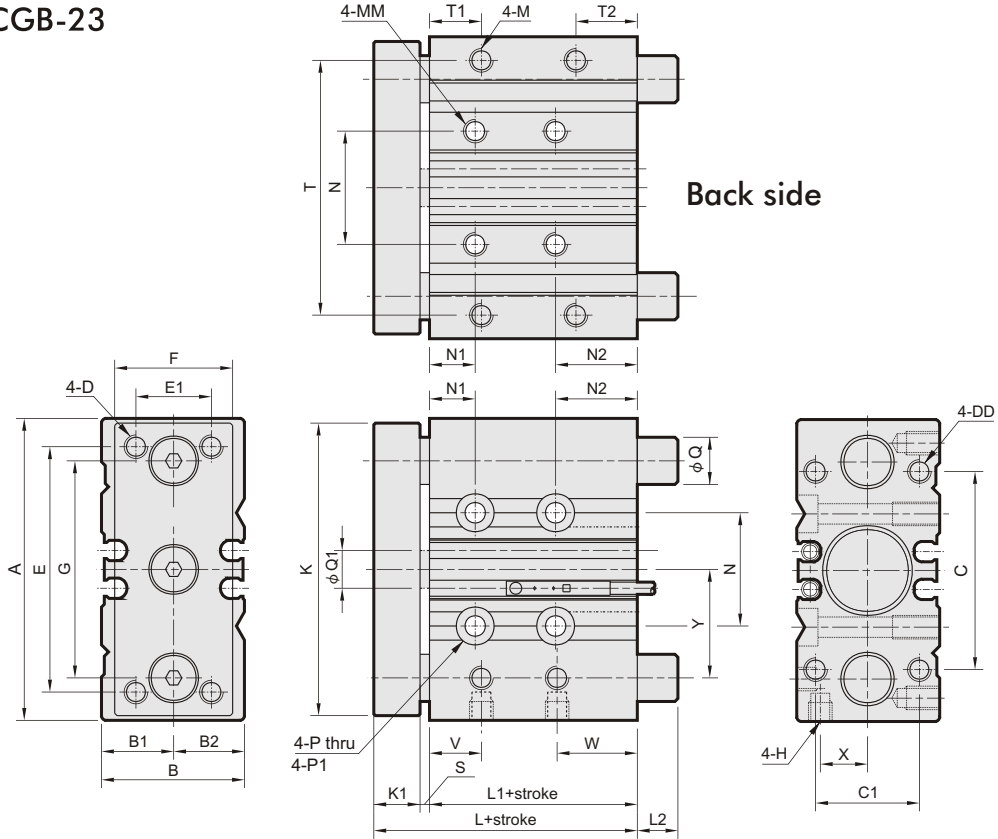

MCGB-03/MCGB-23

Code Tube I.D.	A	B	B1	B2	C	C1	D	DD	E	E1	F	G	H	K	K1	L	L1	L2	M	MM	N	N1	N2	P
12	58	26	13	13	40	18	M4×0.7	M4×0.7×9dp	48	14	22	41.5	M5×0.8	56	8	39	29		M4×0.7×7dp	M5×0.8×10dp	23	5	20	$\phi 4.3$
16	64	30	15	15	42	22	M5×0.8	M5×0.8×11dp	52	16	25	46	M5×0.8	62	10	43	31		M5×0.8×8dp	M5×0.8×10dp	24	5	22	$\phi 4.3$
20	85	36	17	19	52	26	M5×0.8	M5×0.8×13dp	60	18	30	55	PT 1/8	72	10	47	35	*	M5×0.8×7dp	M6×1.0×12dp	28	19	16	$\phi 5.3$
25	96	42	21	21	62	32	M6×1.0	M6×1.0×15dp	70	26	38	65	PT 1/8	86	10	47.5	35.5		M6×1.0×9dp	M6×1.0×12dp	34	22	12.5	$\phi 5.3$
32	116	51	26	25	80	38	M8×1.25	M8×1.25×18dp	96	30	48	80	PT 1/8	112	12	47.5	33.5		M8×1.25×11dp	M8×1.25×16dp	42	22	14.5	$\phi 6.6$

Code Tube I.D.	P1	Q		Q1	S	T	T1	T2	V	W	X	Y
		MCGB-03	MCGB-23									
12	$\phi 8 \times 4.5dp$	8	6	6	2	50	12	12	11	15	8.5	19.5
16	$\phi 8 \times 4.5dp$	10	8	8	2	54	11	13	11	17	10	23
20	$\phi 9.5 \times 5.5dp$	12	10	10	2	64	11	14	12	23	11.5	24.5
25	$\phi 9.5 \times 5.5dp$	16	13	12	2	76	12	13.5	11	23.5	13.5	24
32	$\phi 11 \times 6.5dp$	20	16	16	2	100	12	16.5	11.5	25	16	31

L2 dimensions list

MCGB-03

Tube I.D.	Stroke (mm)											
	10	20	25	30	40	50	75	100	125	150	175	200
12	0	0	/	0	0	0	18	18	/	/	/	/
16	0	0	/	0	0	0	21	21	/	/	/	/
20	/	0	/	0	0	0	14	14	31	31	31	31
25	/	0	/	0	0	0	14	14	31	31	31	31
32	/	/	/	20	20	20	20	20	42	42	42	42

MCGB-23

Tube I.D.	Stroke (mm)											
	10	20	25	30	40	50	75	100	125	150	175	200
12	0	0	/	0	14	14	14	14	/	/	/	/
16	0	0	/	0	21	21	21	21	/	/	/	/
20	/	0	/	0	27	27	27	27	50	50	50	50
25	/	2	/	2	35	35	35	35	50	50	50	50
32	/	/	/	8	8	8	8	42	42	55	55	55

MCGB-03/MCGB-23

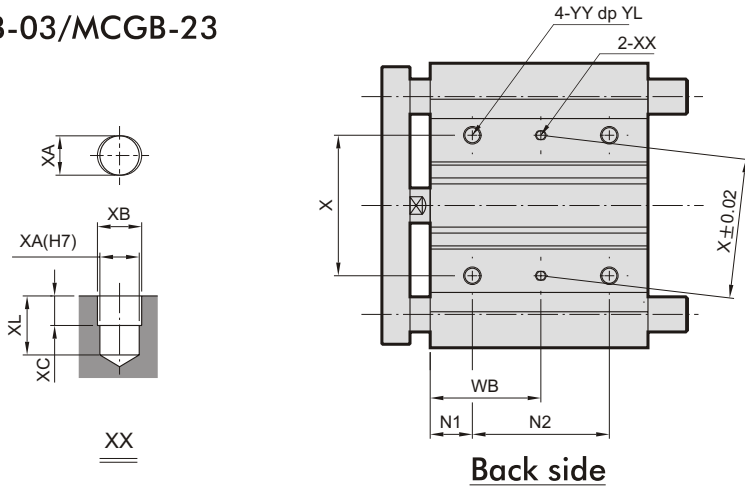

T slot for hexagon head bolt

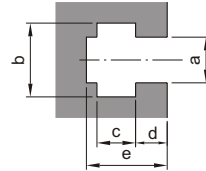

T slot for hexagon head bolt

Tube I.D.	a	b	c	d	e
40	6.5	10.5	5.5	4	11
50	8.5	13.5	7.5	4.5	13.5
63	11	17.8	10	7	18.5

Back side

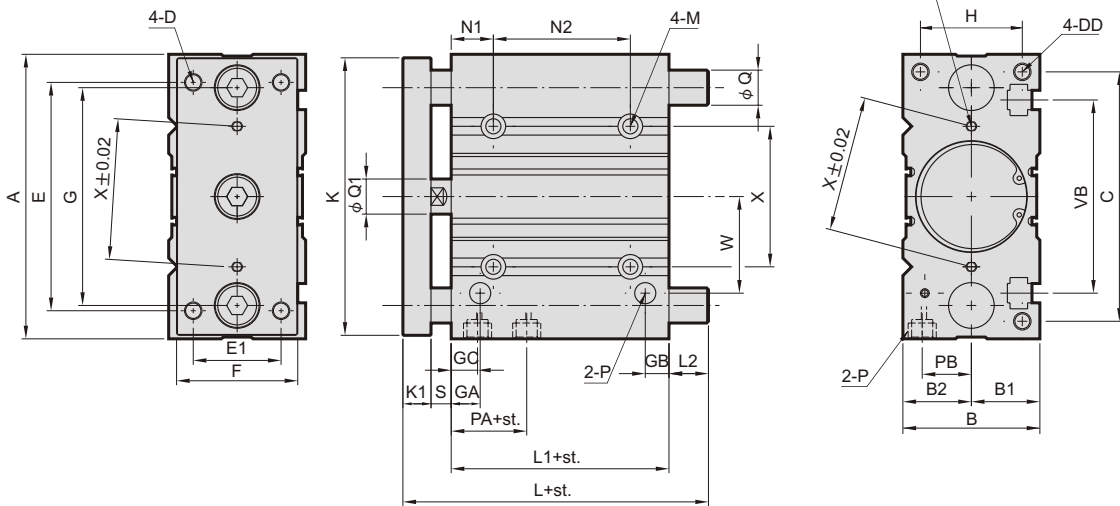

MCGB-03/MCGB-23

Code Tube I.D.	A	B	B1	B2	C	D	DD	E	E1	F	G	GA	GB	GC	H	K	K1	L1	M	N1
40	120	54	27	27	106	M8×1.25	M8×1.25×20 dp	104	30	44	86	14	10	14	40	118	12	44	φ 6.6thru, φ 11×7.5dp	22
50	148	64	32	32	130	M10×1.5	M10×1.5×22 dp	130	40	60	110	14	11	12	46	146	16	44	φ 8.6thru, φ 14×9dp	24
63	162	78	39	39	142	M10×1.5	M10×1.5×22 dp	130	50	70	124	16.5	13.5	16.5	58	158	16	49	φ 8.6thru, φ 14×9 dp	24

Code Tube I.D.	P	PA	PB	Q1	S	VB	W	X	XA ^{H7}	XB	XC	XL	YY	YL	N2			WB		
															25st	50,75,100st	100st-	25st	50,75,100st	100st-
40	PT 1/8	13	18	16	10	72	38	50	4	4.5	3	6	M8×1.25	16	24	48	124	34	46	84
50	PT 1/4	9	21.5	20	12	92	47	66	5	6	4	8	M10×1.5	20	24	48	124	36	48	86
63	PT 1/4	14	28	20	12	110	55	80	5	6	4	8	M10×1.5	20	28	52	128	38	50	88

MCGB-03

Code Tube I.D.	L		L2		Q
	25,50ST	50ST-	25,50ST	50ST-	
40	97	102	31	36	φ 20
50	106.5	118	34.5	46	φ 25
63	106.5	118	29.5	41	φ 25

MCGB-23

Code Tube I.D.	L			L2			Q
	25,50ST	75,100ST	100ST-	25,50ST	75,100ST	100ST-	
40	81	98	118	15	32	52	φ 16
50	93	114	134	21	42	62	φ 20
63	93	114	134	16	37	57	φ 20