

XP-B20

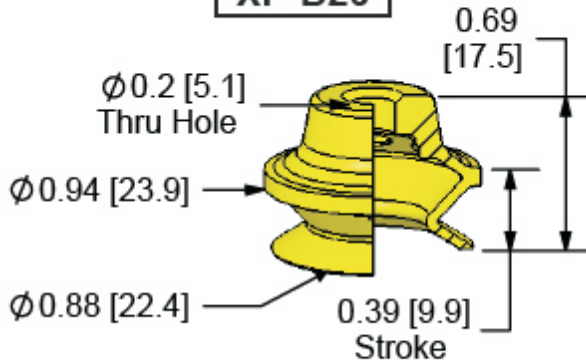

CUP DIAMETER	20 mm
CUP WEIGHT: oz. (g)	0.08 (2.3)
INTERNAL VOLUME: cu. in. (cc)	0.16 (2.6)
FORCE @ 6" Hg: lb. (N)	1.3 (5.8)
FORCE @ 18" Hg: lb. (N)	2.2 (9.8)
MINIMUM RADIUS: in. (mm)	0.39 (9.9)
SHEAR LOAD²: lb. (N)	1.1 (4.8)

MATERIAL - VITON



PART NUMBER

XP-B20V